

HIDROMEK

maestro
SERIES

HMK
102S





HIGH BREAKOUT FORCE

Superior performance of the loader end is one of the features that make HİDROMEK different from competitors. The bucket and arm breakout forces of Maestro Series HMKS are higher than many equivalent machines in their class, enabling the machine to drive into loads without being stressed. The highest loading efficiency level is obtained easily by loading the shovel of 1.1 m³ capacity equipped with 8 teeth.

BACKHOE PERFORMANCE

The fast and powerful backhoe attachment offers increased digging performance and precision together at the same time. Options such as the telescopic dipper (for deeper digging) and quick coupler (for minimizing bucket replacement time) make this a very versatile machine.



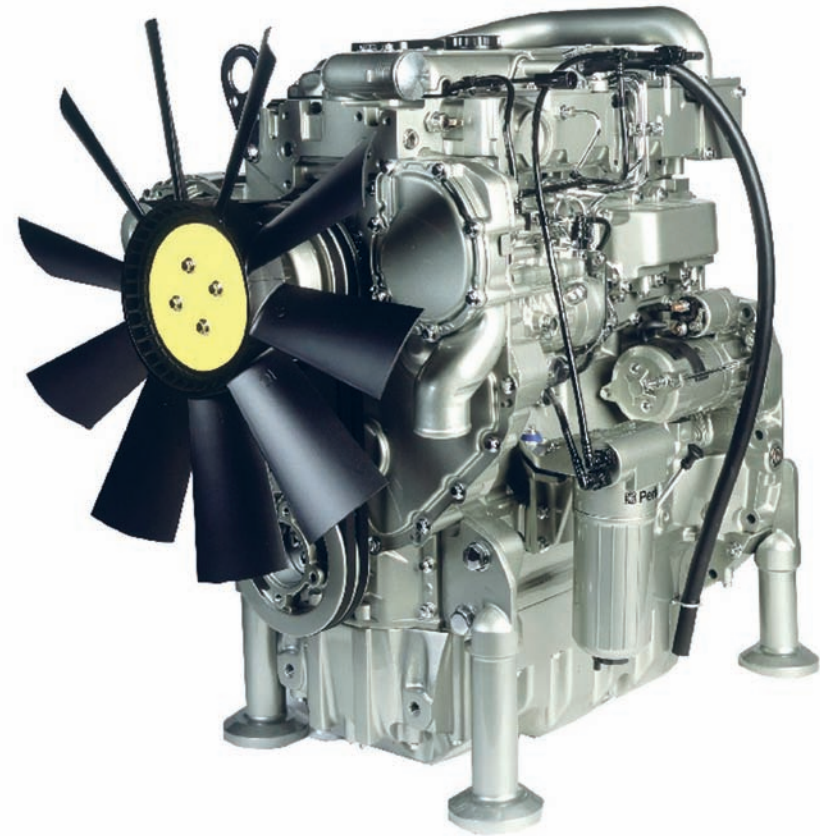

“High productivity through low fuel consumption”

ENGINE

The Maestro Series' Perkins engine is one of the most economical and durable in its class. The turbocharged, 4.400 cm³ engine maintains sufficient power even at low rpm, and reaches its highest torque value (400 Nm) at 1400 rpm. The new generation engine, compatible with USA EPA Tier 3 and European EC Stage III-A exhaust gas emission regulations, combines low emission and low engine noise in an environmentally sensitive package which prevents disturbance and increases operating comfort.

TRANSMISSION

One of the features that make the Maestro Series so powerful is the perfect matching of the diesel engine with the heavy duty autoshift ZF transmission with a torque ratio of 2.87:1.

The electro-hydraulic controlled standard autoshift transmission provides automatic and smooth shifting between 5 forward and 3 reverse gears.

Gear changes and forward-reverse drive are achieved quickly and easily via a gearshift lever mounted on the steering column. This system offers ergonomic ease of use without putting strain on the

operator.

Four wheel drive increases traction in difficult conditions and provides high mobility. It also switches off automatically in 3rd, 4th and 5th gears to improve fuel economy.



AXLES

Tire spin is minimized by heavy-duty front and rear axles which are designed specifically for the Maestro Series. An oscillation angle of 16° of the front axle delivers excellent ground contact and provides operation stability. The rear axle contains oil immersed type discs to provide long service life with no maintenance or adjustment required.

HYDRAULIC SYSTEM

Open Centre hydraulic system is using simple and reliable high efficiency tandem gear pump which is coupled directly to the transmission to increase pump life and prevent power loss. Capable of delivering 154 lt/min (90 lt/min + 64 lt/min) total oil flow at 2200 engine rpm, the gear pump can produce the high pressures needed for years of high efficiency operation and low maintenance costs.

Variable – flow , closed center, regenerative flow sharing (Flowcharger) hydraulic system with axial piston pump which provides highest breakout forces at all engine speeds and delivers 163 lt/min is offered as an option.

TRAVEL SPEED AND FUEL ECONOMY

Driving into material stacks is made easier by the loader through the use of 1st gear which provides increased torque. A maximum travel speed 40 km/h decreases the time spent on the road.

The optimized gear of 5 speed transmission allow smooth hill climbing without loss in power with better fuel economy.



“More spacious,
more comfortable...”

CAB INTERIOR

- Heavy Duty Match Seat
- Adjustable Steering Wheel
- Pockets
- Cool box
- Metal Plate on Floor
- Advanced Air-Conditioning & Ventilating System
- Roof Shelf
- Ergonomic Controls and Hand Brake
- Ergonomic & Elegant Hand Throttle
- CD / MP3 Player
- Ergonomic & Elegant Breaker Pedal
- Easy-to-Open and Wide View One-Piece Rear Window
- Cleanable Interior Roof Lining
- Backhoe Boom Lock Controlled From Inside the Operator's Cabin
- Fops and Rops Certified





STEERING WHEEL

The ergonomically designed steering wheel also provides the operator to work comfortably during long lasting hours and to control the machine easily without leaning from the seat, thanks to the distortion center at the bottom.



HEAVY DUTY MATCH SEAT

The seat specially improved for operator comfort is equipped with weight and height adjustment, waist support, adjustable arm rest, calf support, high adjustable back support which are all provided as standard features.

As for the air suspension seat which is supplied as an optional feature, carries the features of shock impact absorber, waist supporting with double airbags, and automatic weight adjustment.



ERGONOMIC CONTROL

Ergonomics of the backhoe and loader controls are designed for maximum convenience.

BREAKER PEDAL

The breaker pedal with impressive ergonomics and elegant appearance has been re-designed so as not to tire the operator in longtime usage.



JOYSTICK

Enabling the operator to adjust the working position with preferred ergonomics and visibility, optionally supplied joystick controls provide fine control of the backhoe attachment without fatigue. Joystick controls are located at both sides of the seat and the cabin has become more spacious and more comfortable.



HAND THROTTLE

Easy to reach, ergonomically designed hand throttle, provides comfortable operation for operator with easy-to-adjust precise control.



BOOM LOCK

Boom lock controlled by the operator from inside the cabin provides considerable ease of use.

INTEGRATED SAFETY STRUT

Safety strut which is mounted onto the loader cylinder provides easy of use and operator safety.

**OPENING DOOR WINDOWS**

Opening door windows provide air circulation and refreshment within the cab during travel.

WIDENED FRONT VIEW

Vertical convex cab provides comfortable and wide-view operation environment.

**SINGLE-PIECE, EAST-TO-OPEN REAR WINDOW**

The one-piece rear window can be opened easily by its robust structured mechanism, thus providing significant ease of use.

**COOLBOX**

With cooling option in air-conditioned models, materials in storage box are kept cool.

CD / MP3 PLAYER

CD / MP3 player and radio is offered as standard in the cab.

**ADVANCED AIR-CONDITIONING & VENTILATING SYSTEM**

Ventilating centers are placed in optimum areas within the cab so as to provide comfortable operation for the operator.

**POCKETS**

Pockets on the front and side panels in different sizes and shapes for preserving materials or documents inside the cab provide ideal storage and keeping areas.

ROOF SHELF

By offering a roof shelf in machines without air-condition, a new area is created the operator to put his belongings.

**METAL PLATE**

A detachable and washable metal floor mat helps prevent permanent dirt inside the cabin.

“Ease of use - high operational quality”

MSS

The optional MSS (Motion Stabilizer System) works as a shock absorber on the loader lift cylinders. By damping the shock that occurs when a full loader bucket is used on rough terrain, it provides a comfortable ride that is not only smooth but also fast as well.

CUSHIONING SYSTEM

The powerful cushioning system, integrated into the cylinders, softens movement at the ends of the stroke to absorb shock and increase service life.

STABILIZER SAFETY VALVES

Safety valves on stabilizers increase the operational safety of the machine.

EFFECTIVE BRAKING

The Maestro Series have a fully hydraulic double-pedal braking system that is soft, ergonomically controlled and fatigue free.

HIGH MANOEUVRABILITY

An “I” type integrated frame gives the Maestro Series high maneuverability in confined areas, allowing the same job to be completed with fewer motions.

ERGONOMICS and COMFORT

Ergonomically positioned multi-functional instrument panel can be operated easily when working with both the loader and the backhoe.

Soft, ergonomically designed levers allow precise and smooth action, providing efficient movements and preventing strain on the operator for fatigue-free operation throughout the day.

VISIBILITY AND LIGHTING

Wide windows surround the cabin, providing 360° visibility for exceptional command of the work site. Front and rear workspaces are illuminated by four + four powerful ISO-EN (lighting) standard-compliant lights, facilitating night and tunnel work.



ENGINE

Make	: Perkins
Type	: 110 4D-44TA Diesel Engine
Emission Class	: Stage III-A (Tier 3)
Number of cylinders	: 4 in line
Bore & Stroke	: 105 x 127 mm
Displacement	: 4.400 cm ³
Max. Power	: 74.5 kW, 100 hp (2200 rpm)
Max. Torque	: 400 Nm (1400 rpm)
<ul style="list-style-type: none"> • Cold start kit • Dry type, dual element air filter with pre-cleaner • Product of latest technology, reliable, high power and torque output, water cooled, turbocharged, air to air charge cooled diesel engine, requiring low maintenance and assuring extremely low fuel consumption • Compatible with USA EPA Tier3 and European EC Stage III-A exhaust gas emission regulations 	

HYDRAULIC SYSTEM

<ul style="list-style-type: none"> • Simple, reliable and high-efficient tandem gear pump 	
Main Pump at	: 2,200 rpm
Oil Flow	: 90 Lt/min
Pressure	: 230 bar
Auxiliary Pump at	: 2,200 rpm
Oil Flow	: 64 Lt/min
Pressure	: 210 bar
<ul style="list-style-type: none"> • Power Modulation (unloader) valve automatically matching the hydraulic power to varying digging and loading conditions • Anti-shock and anti-cavitation valves • Electrically controlled "Unloader Valve" for preventing unnecessary power consumption by disconnecting the auxiliary pump while travelling on road or whenever the operator requires. • Ergonomically placed "joystick" type loader control lever is designed to prevent operator fatigue. It not only requires minimum operating force but also pleases with high efficiency. • Hyd. oil cooler ensuring problem free operation in a hot climate • 10 micron oil filter • Variable flow, closed center regenerative flow sharing (Flowcharger) hydraulic system with axial piston pump (Optional) 	
Main Pump at	: 2,200 rpm
Oil Flow	: 163 lt/min
Pressure	: 230 bar

AXLES

- Heavy duty service type
- Planetary outboard type reduction gears
- Total 16 degrees total oscillation on the front axle

STEERING

- Full hydrostatic, load sensing
- Soft-touch steering wheel
- Electrical controlled 3 different steering modes:
 - A- 2-wheel front steering for road drive
 - B- 4-wheel steering for tight turns
 - C- 4-wheel "crab" steering for close-to-wall digging and ditch closing

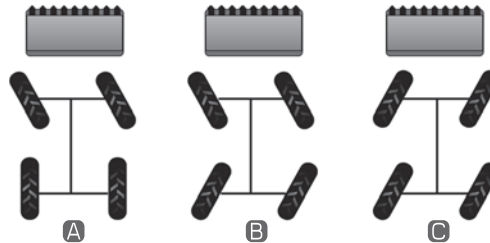

FILLING CAPACITIES

Engine Oil Pump	:	11.0 Lt.
Engine Cooling System	:	18.5 Lt.
Fuel Tank	:	145.0 Lt.
Hydraulic Oil Tank	:	70.0 Lt.
Transmission Oil	:	15.5 Lt.
Front Axle Differential	:	18.0 Lt.
Front Axle Hub Reducers	:	2x2 Lt.
Rear Axle Differential	:	18.0 Lt.
Rear Axle Hub Reducers	:	2x2 Lt.

TRANSMISSION

- Autoshift ZF transmission for heavy duty service
- Torque converter with 2,87: 1 stall ratio
- Electrically controlled 2 Wheel Drive or 4 Wheel Drive selection
- 5 forward, 3 reverse gears
- A neutral circuit allows starting only when the control lever is in neutral position for safety.
- Transmission oil cooler

DRIVING SPEEDS

At 2200 rpm engine speed:		
1 st gear	:	6 km/h
2 nd gear	:	11.5 km/h
3 rd gear	:	17 km/h
4 th gear	:	27 km/h
5 th gear	:	40 km/h

BRAKES

Service Brakes : Self-adjusting, multi-disc oil bath type, hydraulically actuated brakes are located in the rear axle and act on 4 wheels

Parking Brakes : Hand-lever operated mechanical brake acts on the rear axle differential.

ELECTRICAL SYSTEM

Voltage	: 12 V
Battery	: 165 Ampere / Hours, heavy duty type
Alternator	: 65 Ampere
Starter Motor:	3 Kw

LOADER PERFORMANCE

4 in 1 bucket capacity (m ³)	:	1.1
Max. bucket breakout force (kgf)	:	7203
Max. loading arm breakout force (kgf)	:	6513
Lifting capacity to maximum height (kg)	:	3016
Maximum lifting capacity 7'4" (2.23 m)	:	3992
Maximum lifting capacity 7'8" (2.33 m)	:	3923

BACKHOE PERFORMANCE

	NB	TB (extended)	TB (retracted)
Bucket capacity	0.17m ³	0.17m ³	0.17m ³
Max. bucket breakout force	6209	6358	6358
Max. dipper breakout force	2983	2022	2859

WEIGHT

Operating weight (with standard equipment)	: 9,150 kg
Operating weight (with telescopic boom)	: 9,300 kg

Warning

HIDROMEK has the right to modify the specifications and design of the model indicated on this brochure without prior notice

TIRES

Front, Rear : 16.9 - 28 12 Ply Rating

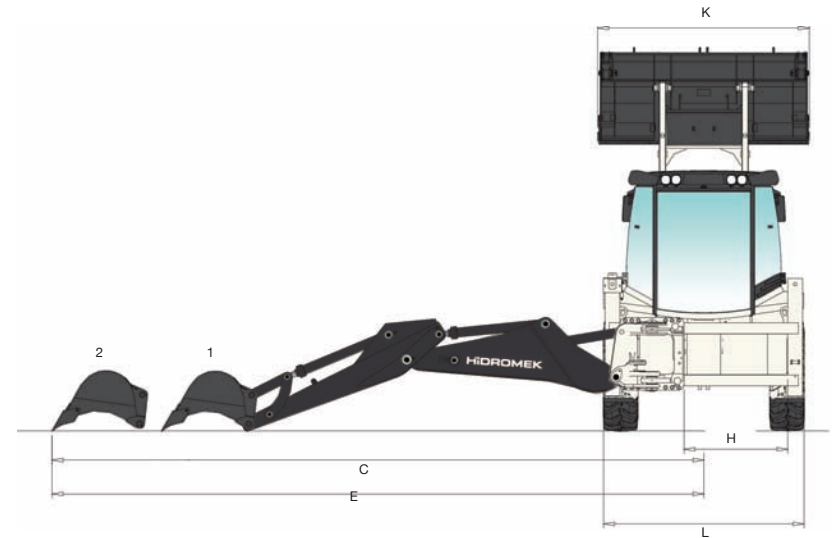
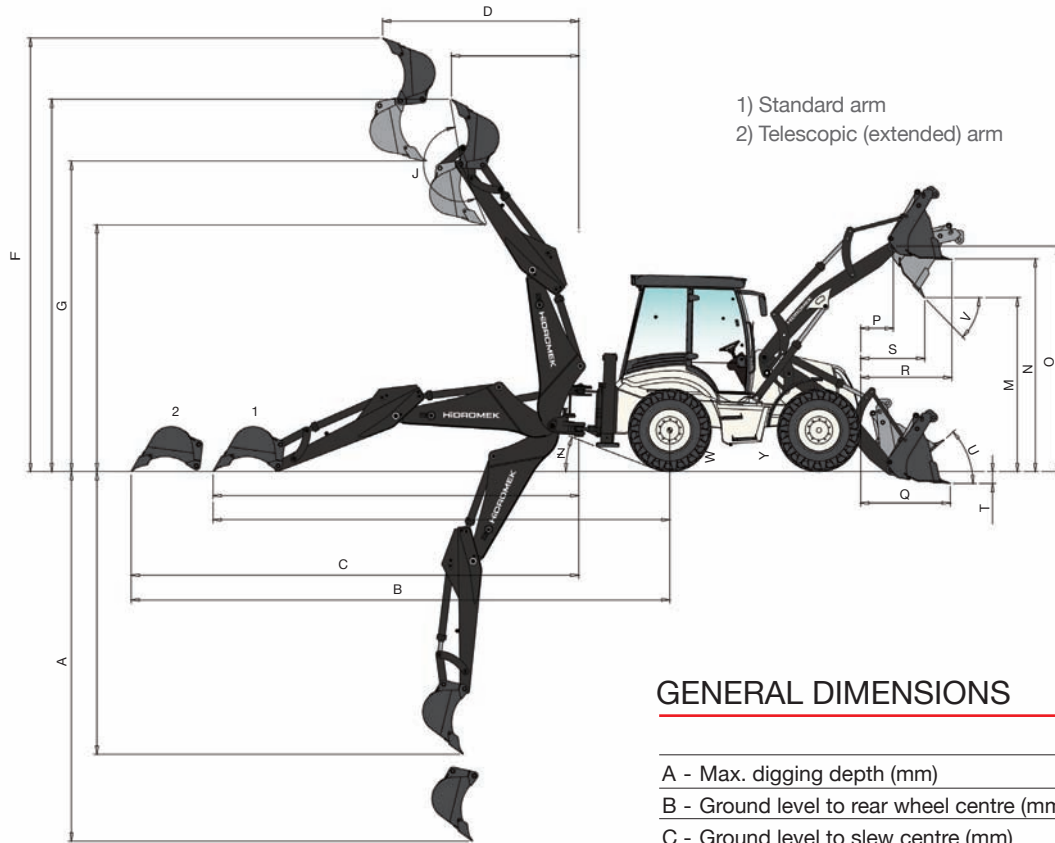

GENERAL DIMENSIONS

	NB	TB (extended)	TB (retracted)
A - Max. digging depth (mm)	4345	5703	4488
B - Ground level to rear wheel centre (mm)	6989	8244	7092
C - Ground level to slew centre (mm)	5599	6854	5703
D - At full height to slew centre (mm)	1987	3087	2236
E - To centre line of machine (mm)	6199	7452	6307
F - Operating Height (mm)	5666	6552	5675
G - Maximum loader height (mm)	3749	4679	3802
H - Total kingpost travel (mm)	1187		
J - Bucket rotation (°)	193°	187°	
K - Shovel width (mm)	2440		
L - Rear frame width (mm)	2292		
M - Dump height (mm)	2690		
N - Load over height (mm)	3260		
O - Loader hinge pin height (mm)	3470		
P - Pin forward reach (mm)	480		
Q - Reach at ground (toe plate horizontal) (mm)	1375		
R - Max. reach at full height (mm)	1370		

GENERAL DIMENSIONS

	TB (extended)
S - Reach at full height fully dumped (mm)	960
T - Dig depth (mm)	160
U - Roll back at ground (°)	43°
V - Dump angle (°)	45°
Y - Front wheel center to ground (mm)	650
Z - Departure angle (°)	20°
W - Rear wheel center to ground (mm)	625
X - Distance between pin center and ground (mm)	250
AA - Total travel length (mm)	6090
BB - Axle centreline distance (mm)	2280
CC - Slew centre to rear axle center distance. (mm)	1395
DD - Stabiliser feet clearance (mm)	355
EE - Kingpost clearance (mm)	510
FF - Steering wheel centre height (mm)	2075
GG - Cab roof height (mm)	3025
HH - Total travel clearance (mm)	3600

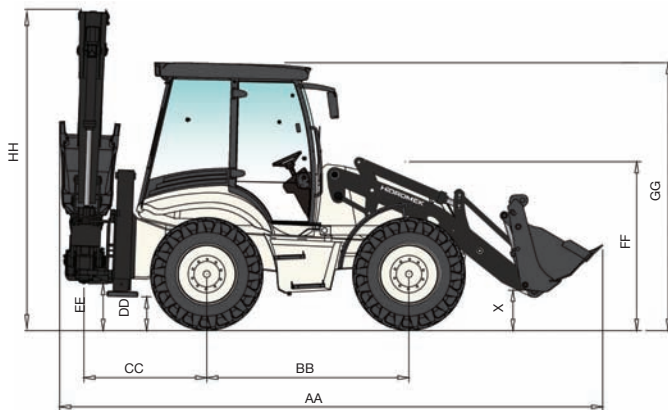

STANDARD EQUIPMENTS

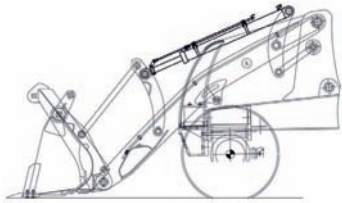

RTD (Return to Dig)
Automatically adjusts the bucket angle suitable for the digging position

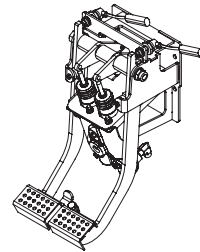

Double Brake Pedals
Ability of applying brakes on left and right wheels independently



Cushioning System
Softens movements at the ends of the stroke to absorb shock and increase service life

Standard equipment list

- RTD
- Immobilizer
- CD / MP3 Player
- Cushioning System
- 4-in-1 Loader Bucket
- Double brake pedals

OPTIONAL EQUIPMENTS

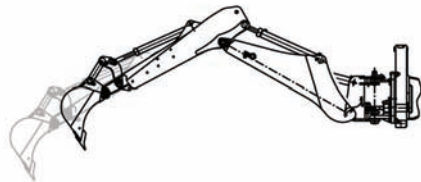

Telescopic Dipper
Digging depth of 5.8 mt. Safety lock against uncontrolled extension

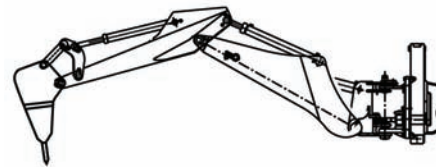

Hydraulic Breaker Installation
Hydraulic breaker installation with quick-fit coupling

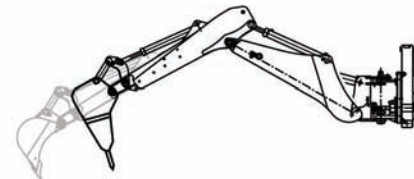

Hydraulic Breaker Installation + Telescopic Dipper
The benefit of digging deep by telescopic dipper besides using hydraulic breaker

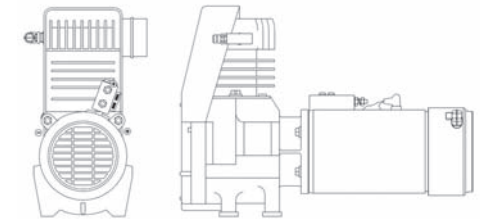

Air Compressor
65 cm³ capacity, working max. at 1600 rpm , portable, electrical compressor for inflating tires



A/C

Air Conditioner
The benefit of working in a cool and comfortable environment free of dust and noise

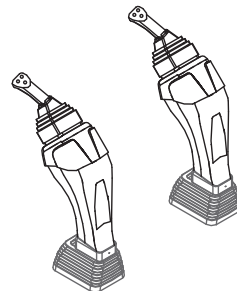

Joystick
Joystick controls as an option for ergonomic control of the backhoe attachment.



MSS
Motion Stabilizer System can absorb dynamic loads that may occur on rough terrain

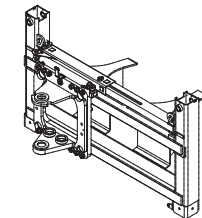

Powerslide
The position of backhoe carriage can be hydraulically moved to left side and right side

OPTIONAL BACKHOE ATTACHMENTS

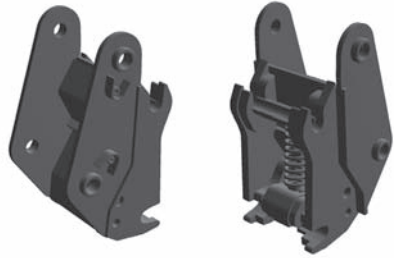

Quick Coupler



Hydraulic Breaker



Auger



Finishing Bucket

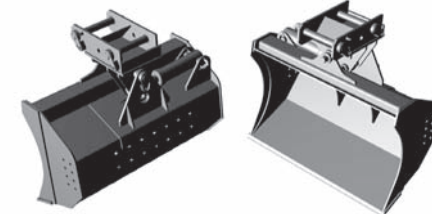

Offset Bucket



Clamshell Grap



Ripper



Trapezoidal Ditch Bucket



Backhoe Buckets of Different Sizes

Bucket Width (mm)	Bucket Capacity (m ³) Heaped	Bucket Capacity (m ³) Struck	Empty Weight (+teeth) (kg)	Teeth Number
350	0.08	0.06	128.5	3
400	0.09	0.07	141.5	3
500	0.11	0.08	149.5	3
600	0.14	0.10	167	4
700	0.18	0.13	185	4
800	0.22	0.15	200.5	5
900	0.25	0.17	210.5	5

Backhoe Bucket Properties

OPTIONAL LOADER ATTACHMENTS



Hydraulic Quick Coupler

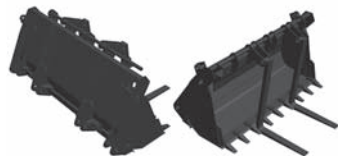

4-in-1 Bucket with Forklift Attachment



One-piece Bucket



4-in-1 Bucket with Quick Coupler



Forks Mounted on Quick Coupler



4-in-1 Bucket with Auger

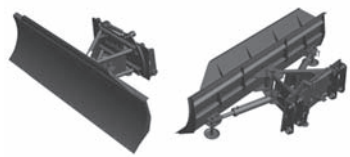

Tilting Grading Blade



Grading Blade



Timber Grab with Propulsion



Timber Grab with 3 Clamps



Timber Grab with 5 Clamps



Timber Grab with Forks

WARNING

- Optional attachment and accessory standards offered along with machines may differ according to countries.
- Please consult your authorized dealer to provide attachments and accessories.



Joystick*



Autoshift transmission

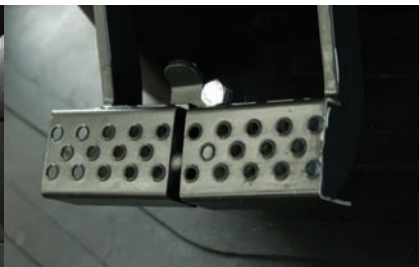

Double pedal brake system



Cup holder and storage



Multifunctional and proportional control lever



Single-piece, east-to-open rear window



Wide visibility



Improved sound-proofing



Recessed loader struts and aesthetic hose routing



Highly effective head lamps



"I" beam type frame suitable for heavy duty service



Stronger loader arm mechanism

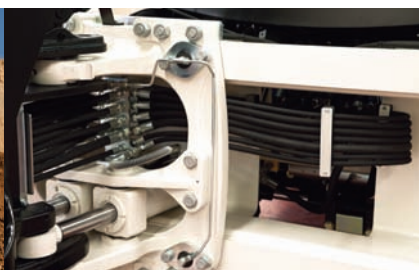

Heavy duty monoblock kingpost carriage with centrally mounted hydraulic cylinders

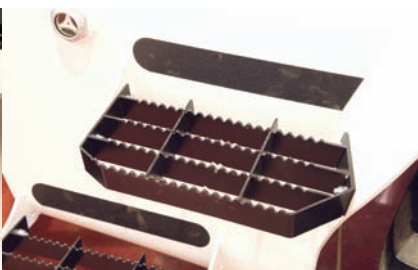

Anti-Slip removable and folding type footsteps



Backhoe boom and slewing lock controlled from inside the operator's cabin

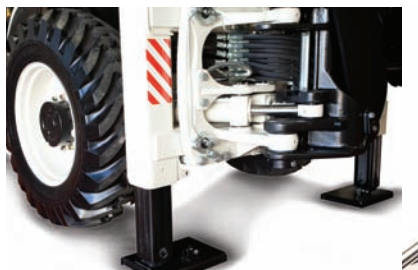

Wider stabilizer pads



Noise and vibration free improved exhaust system



Levelling position bar



4-Wheel steering for tight turns



MSS motion stabilizer system* and higher top speed

* Optional



HIDROMEK

www.hidromek.com

Your Local Distributor:

FACTORY - HEAD OFFICE

Ayaş yolu 25.km 1. Organize Sanayi Bölgesi Osmanlı Caddesi No: 1
06935 Sincan / ANKARA / TURKEY
Phone: (+90) 312 267 12 60 Fax: (+90) 312 267 21 12
www.hidromek.com email: export@hidromek.com.tr

Warning

HIDROMEK has the right to modify the specifications and design of the model indicated on this brochure without prior notice